

# STANDARD TRIMS

N.B.: Other products also available; see Flashings and Mouldings. \*Measurement to be determined.

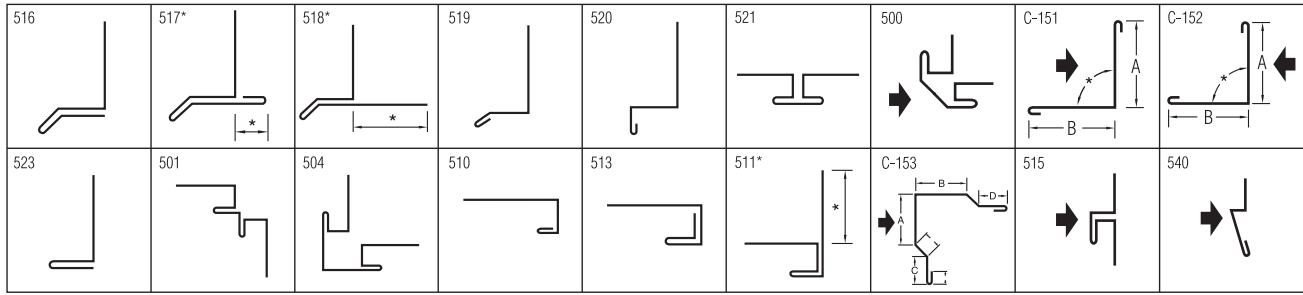

## ESTIMATING CHART

Coverage @ 30" (0.762 m) per sheet:

No. OF SHEETS	COVERAGE			No. OF SHEETS	COVERAGE			No. OF SHEETS	COVERAGE		
	FT.	INS.	M		FT.	INS.	M		FT.	INS.	M
1	2	6	0.762	16	40	0	12.192	31	77	6	23.627
2	5	0	1.524	17	42	6	12.954	32	80	0	24.384
3	7	6	2.286	18	45	0	13.716	33	82	6	25.146
4	10	0	3.048	19	47	6	14.478	34	85	0	25.908
5	12	6	3.810	20	50	0	15.240	35	87	6	26.670
6	15	0	4.572	21	52	6	16.002	36	90	0	27.432
7	17	6	5.334	22	55	0	16.764	37	92	6	28.194
8	20	0	6.096	23	57	6	17.526	38	95	0	28.956
9	22	6	6.858	24	60	0	18.288	39	97	6	29.718
10	25	0	7.620	25	62	6	19.050	40	100	0	30.480
11	27	6	8.382	26	65	0	19.812	41	102	6	31.242
12	30	0	9.144	27	67	6	20.574	42	105	0	32.004
13	32	6	9.906	28	70	0	21.336	43	107	6	32.766
14	35	0	10.668	29	72	6	22.098	44	110	0	33.528
15	37	6	11.430	30	75	0	22.860	45	112	6	34.290

## GABLE SHEET LENGTH

To determine number of sheets required, use preceding table.

**Gable End with even number of sheets.**  
Use ends cut off sheets to cover second gable.

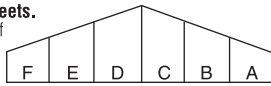

**Gable End with odd number of sheets.**  
Use ends cut off sheets to cover second gable.

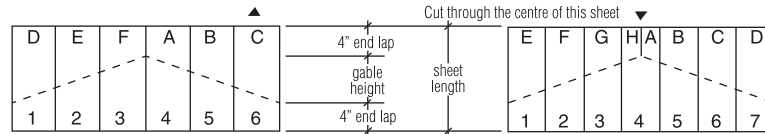

## CONVERSION FACTORS

<b>To Convert</b>	<b>Multiply by</b>
Inches to millimeters	25.4
Millimeters to inches	0.03937
Feet to meters	0.3048
Meters to feet	3.281

<b>To Convert</b>	<b>Multiply by</b>
Sq. feet to sq. meters	0.0929
Sq. meters to sq. feet	10.76
Pounds to kilograms	0.4536
Kilograms to pounds	2.205



In accordance with ongoing efforts to improve our products and their performance, Vicwest Building Products reserves the right to change without notice the specifications contained herein.

The contents herein are for general information and illustrative purposes only and are not intended to serve as any type of advice. Every effort is made to ensure the accuracy of the information included in this brochure and it is believed that the information contained herein is accurate and reliable as of the date of publication. Vicwest Building Products, however, does not warrant or represent the accuracy or reliability of any information included in this brochure. Any reliance on any information without consultation with Vicwest Building Products or a duly authorized representative shall be at the user's own risk. © 2015 Vicwest Building Products – All rights reserved



VW00179EN03/15

## For Roof or Walls

GRAND RIB

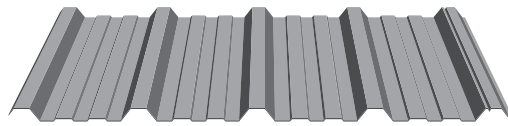

CL 4012

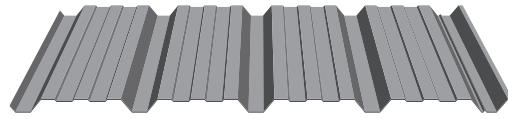

# GRAND RIB CL 4012

Manufactured in Victoriaville, PQ

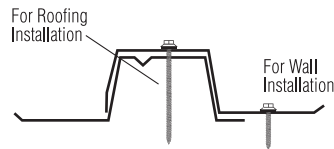

Recommended Overlap Procedure

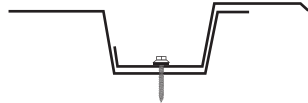

Recommended Overlap Procedure

### GRAND RIB

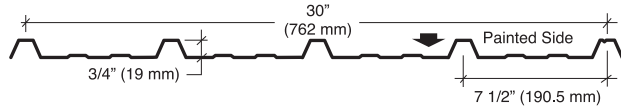

CL 4012 is the reverse of Grand Rib

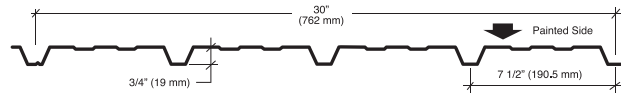

FINISH	MATERIAL GAUGE				LENGTH MAXIMUM RECOMMENDED
	30	28	26	24	
GALVALUME	•	•	•		4' to 30'
GALVANIZED	•	•	•	•	4' to 30'
PRE-PAINTED	•	•	•	•	4' to 30'

### STEEL:

- Galvanized and Galvalume
- Pre-painted Galvanized WeatherXL™ series (see Vicwest standard colors).



### APPLICATION - Walls and Roofs

#### MATERIAL SPECIFICATIONS:

The steel used in the manufacture of GRAND RIB sheet meets the following specifications:

- ASTM A653 (latest revision) Structural Steel Grade 33  
- for all thicknesses, with designation G90.
- ASTM A792, (latest revision) Structural Steel Grade 30  
- for Galvalume, with designation AZ50 (AZM150)  
- for Galvalume Plus, with designation AZ50 (AZM150)  
- for Galvalume Plus, with designation AZ180

Appearance and versatility are the major assets of GRAND-RIB. Designed with five 0.75" (19mm) ribs with clear, bold, modern lines, it will give your building a look of distinction.

An anti-seepage rib offers a watertight lap design on roofs 3/12 pitch or more, with taped sidelaps on recommended fastening centres of 16".

# ROOFING ACCESSORIES

## Ridge Cap FA-8 / FA-12

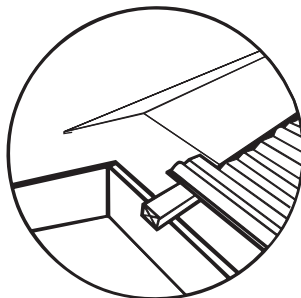
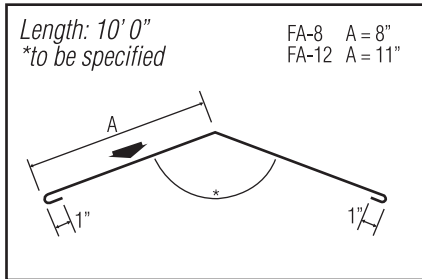

## Universal Valley

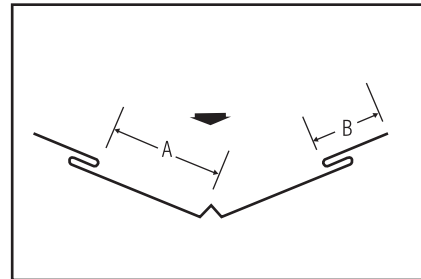

## Hip Cap C-145

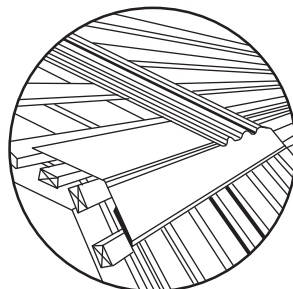
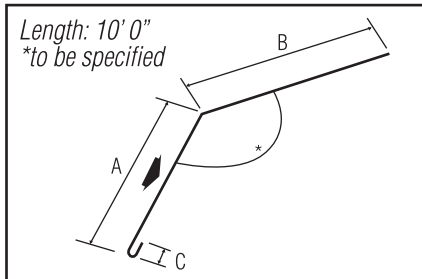

## End Wall C-121

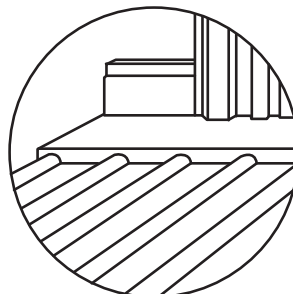
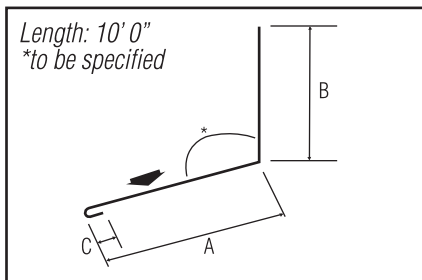

▲▲ Outside (prepainted)

N.B: Other products also available; see Flashings & Mouldings.

## Fiberglass

**Coverage:** 30" (762 mm)  
**Weight:** 5 oz.  
**Length:** 8' 0"  
**Colors:** Clear and Green  
 Available on request.

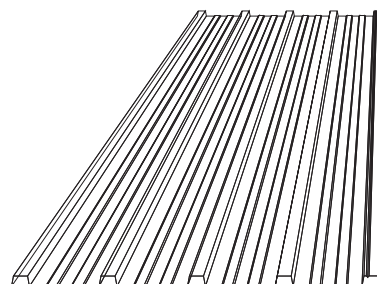

# WATERPROOFING AND SEALING

For best waterproofing results, we recommend the use of the following products:

## Foam Closures - Crosslinked Polyethylene

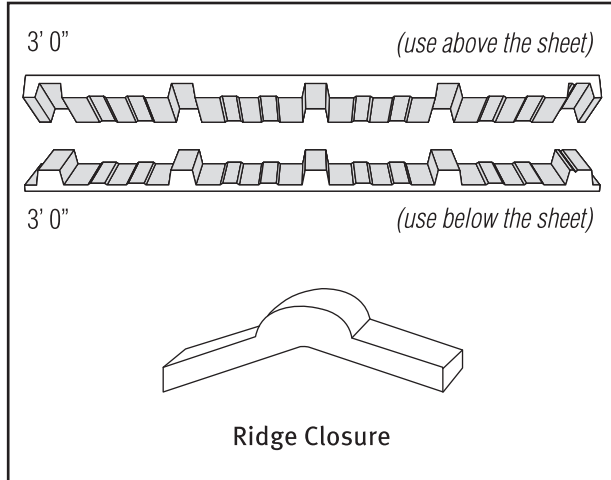

## Metal Building Tape

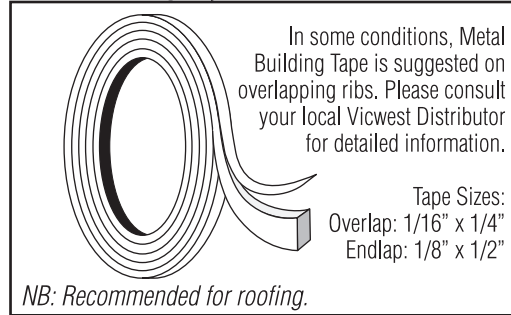

## Sealant

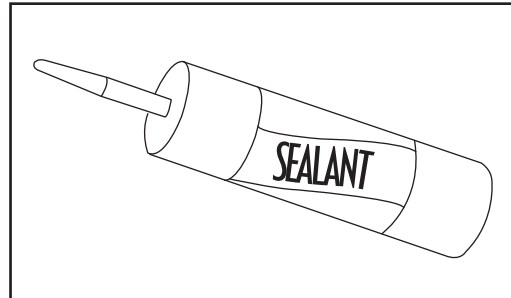

# VENTILATION

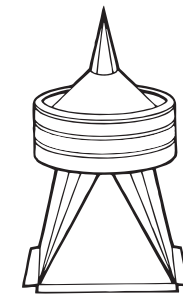
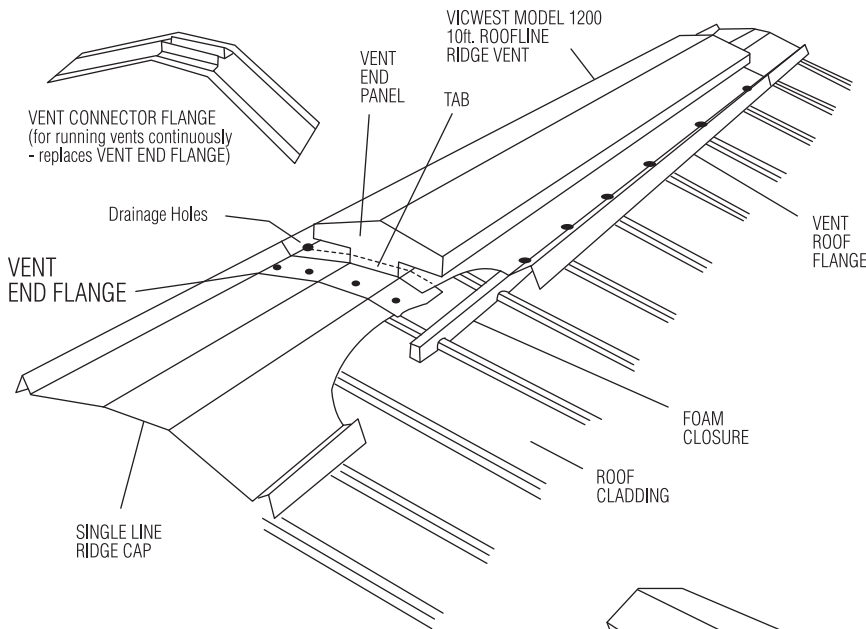

Round Ventilator

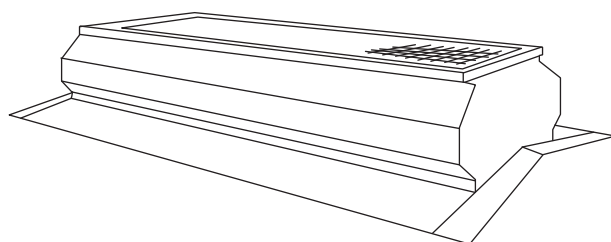

Low Profile Ventilator #480

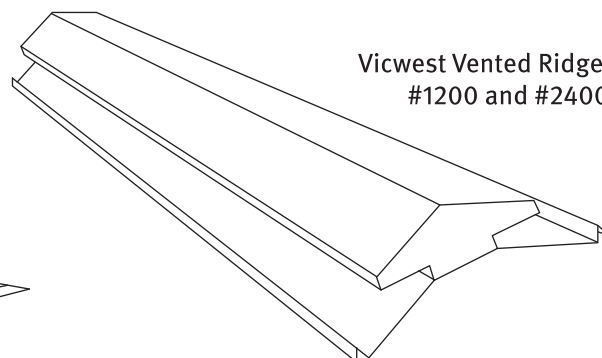

Vicwest Vented Ridge #1200 and #2400